



**SMART**

# Titan - 500

Long Range System

# INDEX

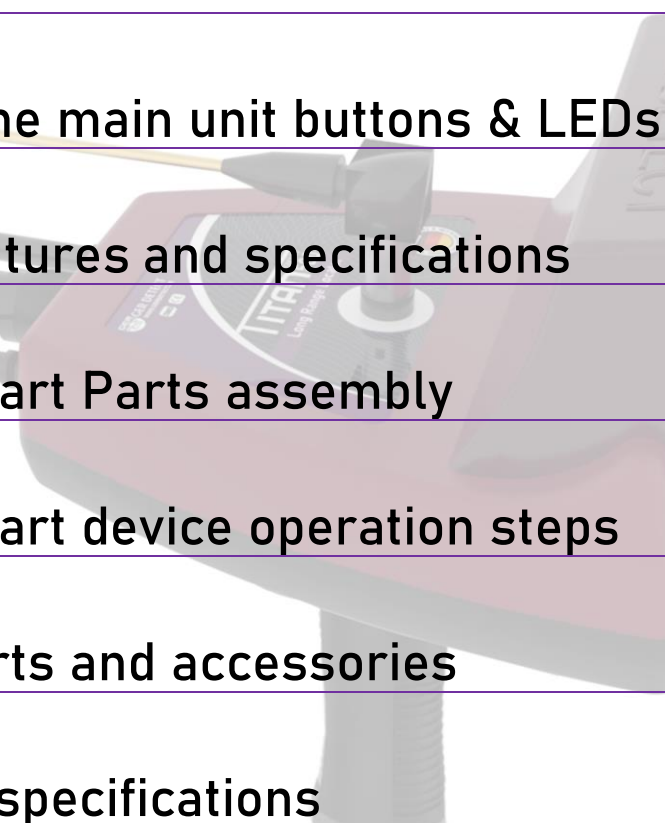
- **Section 1:**  
Critical Warning
  - **Section 2:**  
Overview
  - **Section 3:**  
Definition of the main unit buttons & LEDs
  - **Section 4:**  
The device features and specifications
  - **Section 5:**  
TITAN 500 Smart Parts assembly
  - **Section 6:**  
TITAN 500 Smart device operation steps
  - **Section 7:**  
The device parts and accessories
  - **Section 8:**  
The technical specifications
- 



## Critical Warning

- Please be sure that all precautions are taken against risks.
- Do not use your device while it is raining.
- Turn on the device after you make sure that all parts are in place and connected.
- Make sure that the device battery is fully charged before you start searching.
- If the indicator on the side of the device starts flashing, turn off the device and recharge the battery.
- When the battery will almost die the device will turn off automatically.
- It is recommended to read the user manual before starting on the device to understand everything and to avoid mistakes through the search.
- Be aware of (energy sources - phone networks - metals - mobile phones - electronic devices), and do not use any charger other than the original one of the device.
- The device main unit is under two (2) years warranty against all electronic breakdowns, any damages caused by user errors (falls, opening the main unit, hits, harms, etc.) are not covered within this warranty.
- Battery and charger are not under the warranty.
- You should strictly follow the instructions in this user manual to minimize faults and to use your device correctly.
- If the device is not used correctly, or there is a high rate of noise, in these cases the device will not be capable of confirming the target and determining the depth.

We wish you all the best of luck in your search.....



## (Overview)

Dear customer,

“Thank you for choosing TITAN 500 SMART”

- ✓ It has completely developed the device into a TITAN 500 SMART device with the addition of more systems and the development of the device's characteristics with new professional techniques in capturing targets from long distances with high accuracy and determining the depth more easily and accurately.
- ✓ TITAN 500 Smart is a multi-functional device for searching for diamonds, precious stones, gold, and precious metals in the ground.
- ✓ Searching for large and small diamonds.
- ✓ Search for gems and capacity to discover 18 different species: Sapphire, Emerald, Quartz, Topaz, Granet, Amethyst, Lapis Lazuli, Tourmaline, Columbite, Tanzanite, Turquoise, Peridot, Alexandrite, Cat Eye, Ruby, Jasper, Opal, Aquamarine.
- ✓ Searching for precious metals such as ancient buried gold – gold nugget platinum – silver – bronze – zircon – cobalt – coltan – copper – mercury – meteorites – osmium.
- ✓ The search depth of the TITAN 500 Smart device reaches up to 120 meters in the ground and the front range is 3000 meters.
- ✓ The device works in six languages: German – English – French – Spanish – Italian – Arabic.
- ✓ The TITAN 500 SMART device is one of the best German manufacturers. It has the European CE certificate according to international specifications, in addition to the international ISO 9001 certificate according to international specifications and standards.
- ✓ This device is designed to be compatible with its functioning in all countries and regions.

## Definition of the main unit buttons & LEDs

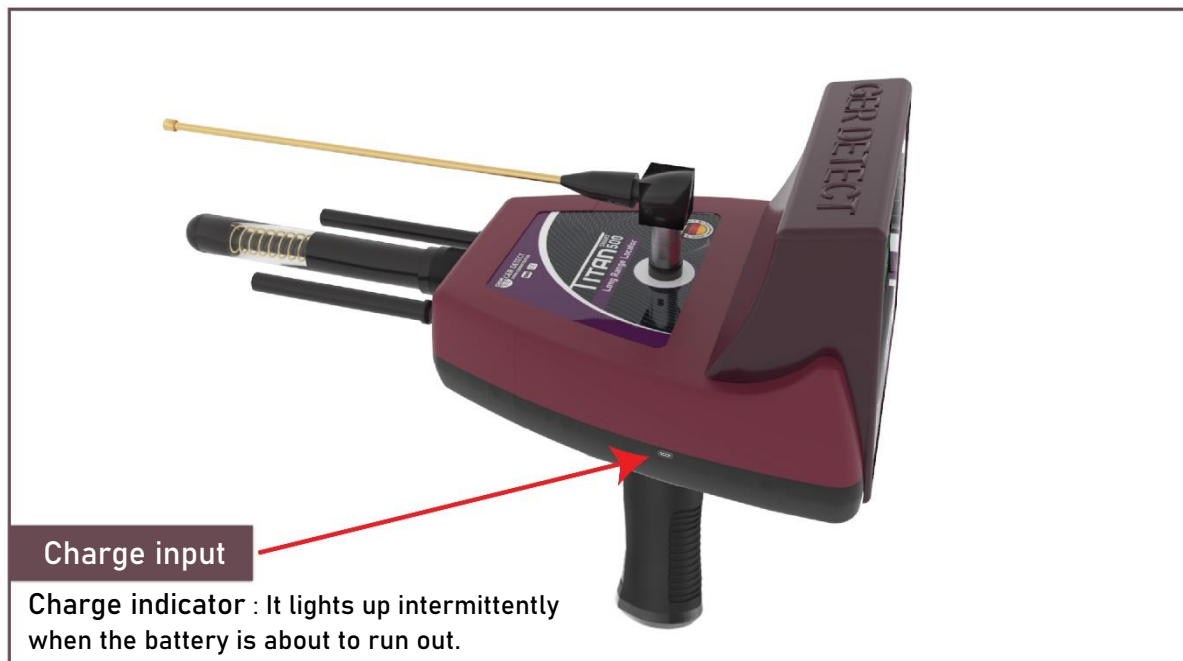
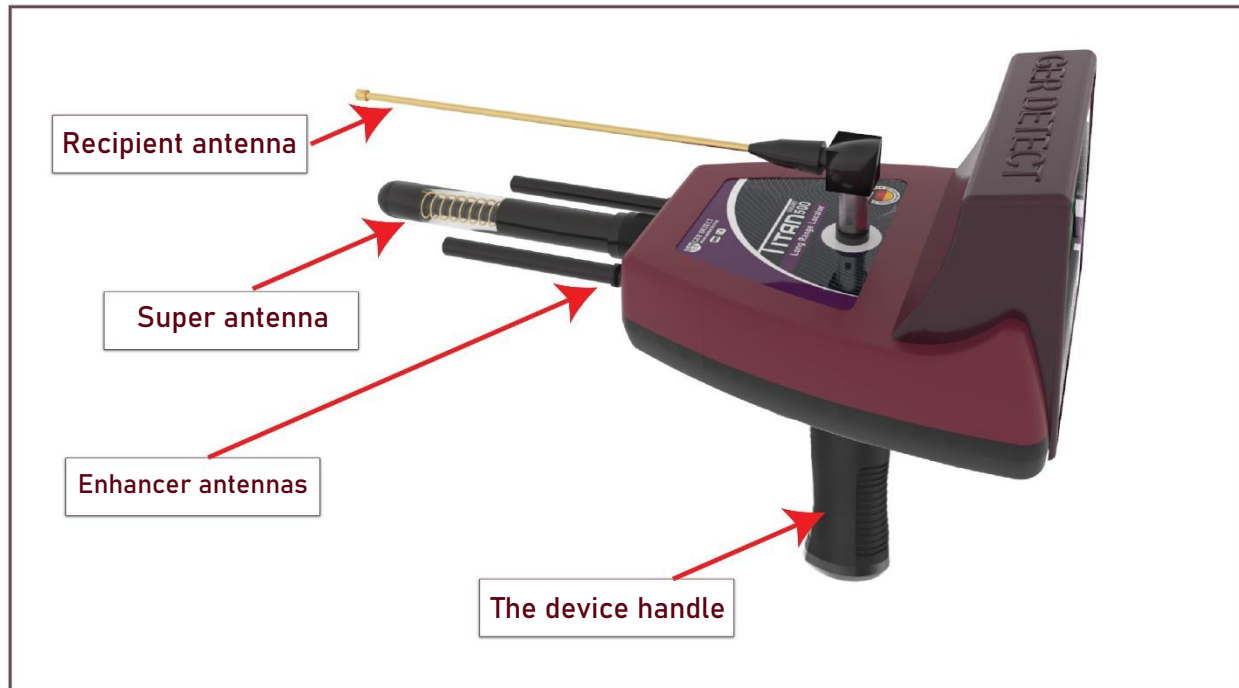

## The device features and specifications

The Titan 500 Smart device has multiple features to search for gold, buried treasures, precious metals, and diamonds in the ground:

- Super speed in capturing targets and locating them accurately.
- The system for determining the target depth easily and accurately.
- The system for specifying the continent in which you search.
- A screen that supports the touch system which contains many advantages and features.
- An electronic thermometer within the device screen that measures the weather temperature.
- A digital clock
- The possibility of muting and activating the device's sound.
- Super Antenna which enables the device to cover large areas of research.
- A radar search dish to receive and improve the signal.

## Titan 500 Smart device parts connection

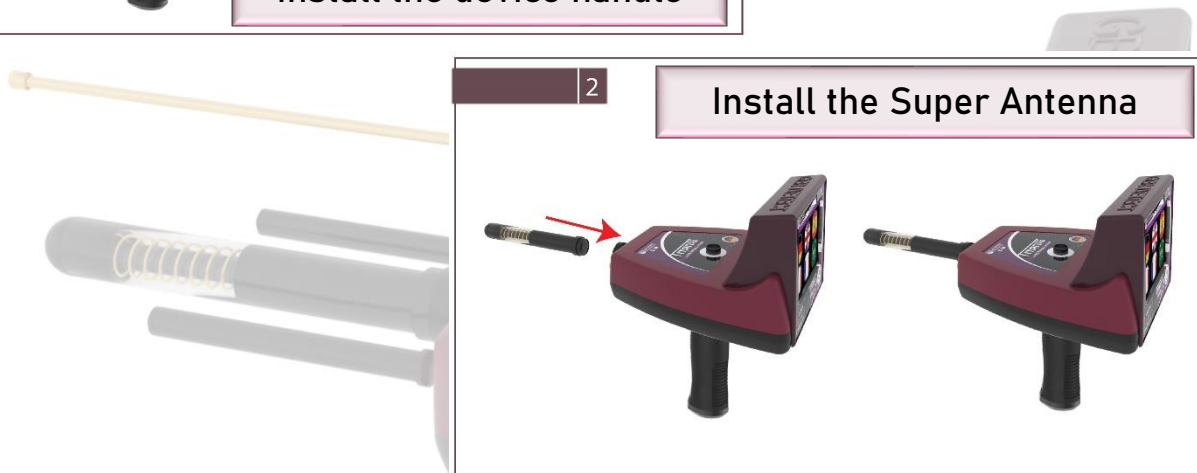

## Titan 500 Smart device operation steps



After turning on the device, the following data will appear on the main screen:

Battery level indicator - clock - temperature - activate and mute button.





1- Settings icon:

It contains the working languages of the device, which are:

German - English - French - Spanish - Italian - Arabic

Device settings icon through which you can set:

Sound level - brightness level - time settings - device information

Locate and choose the continent icon you want to search in.

This unique feature was added due to the different frequencies of underground minerals from one continent to another.

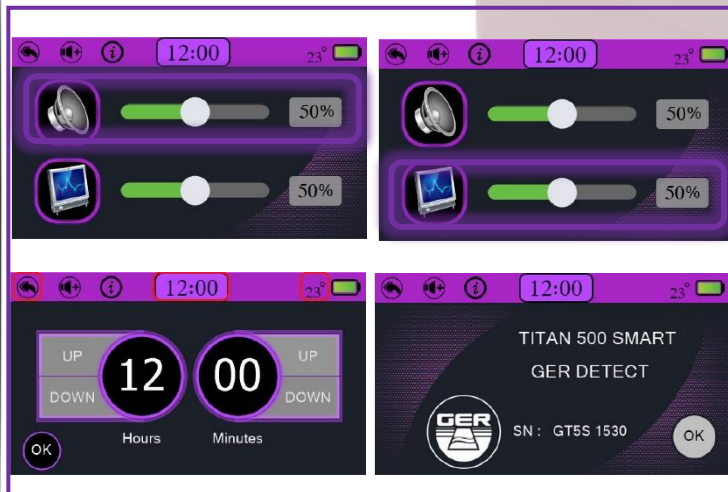

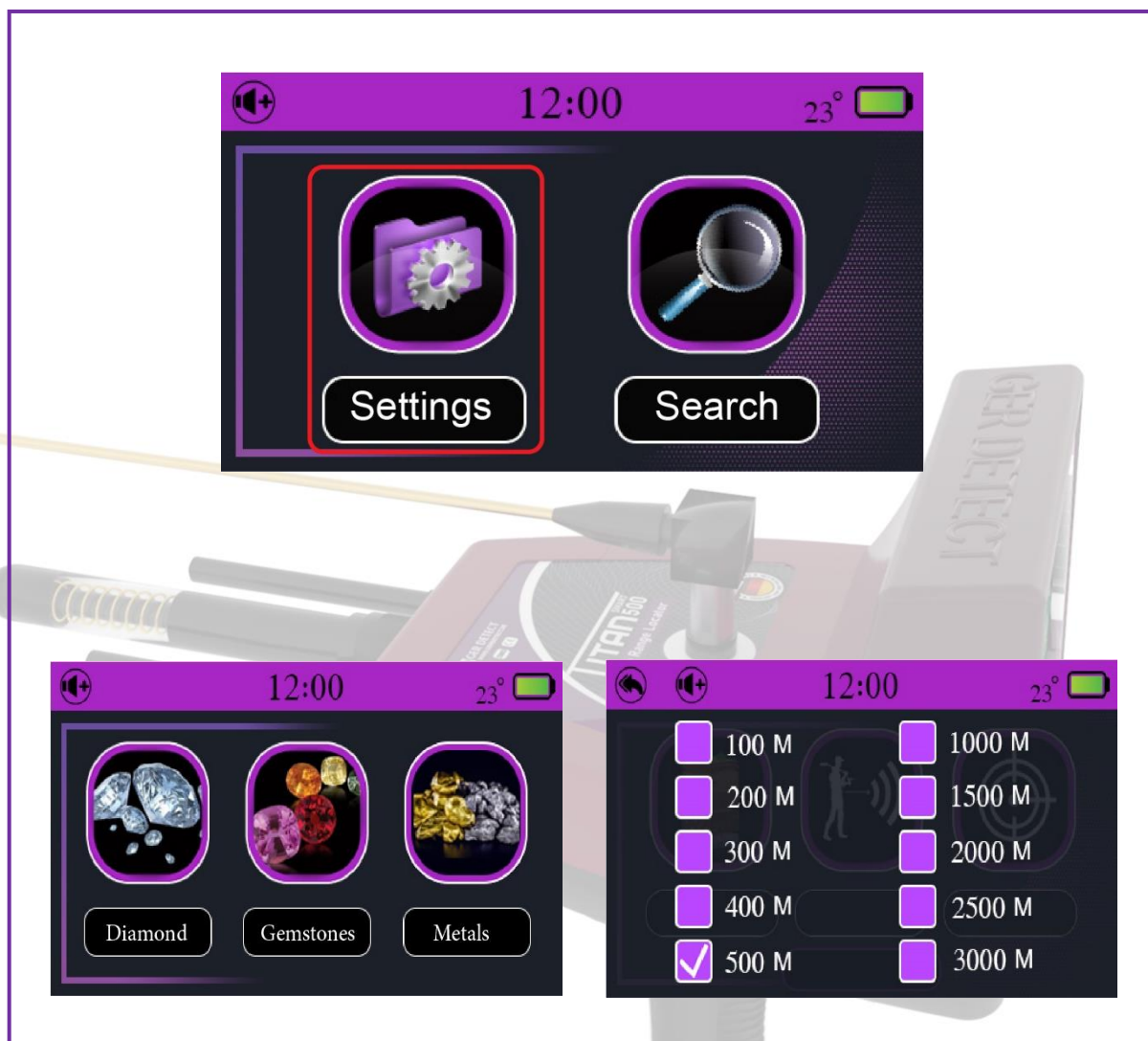

## 2- Search options:

Choose the type of target you want to search underground.

Determine the front range of the device.

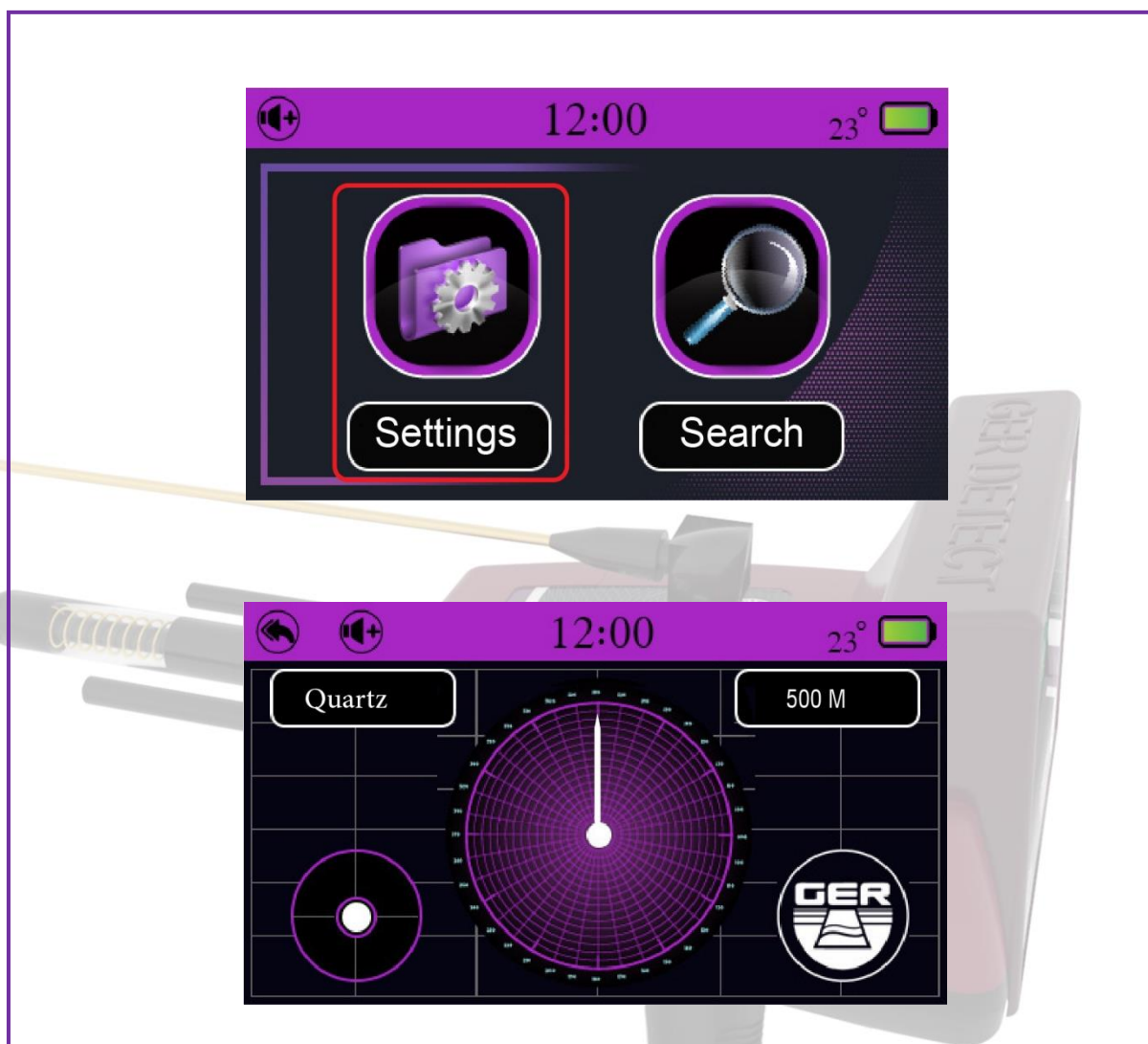

### 3- Search icon:

When you press the search icon, the device will directly start searching, depending on the preset settings saved by the prospector, which are (target type - front range - continent).

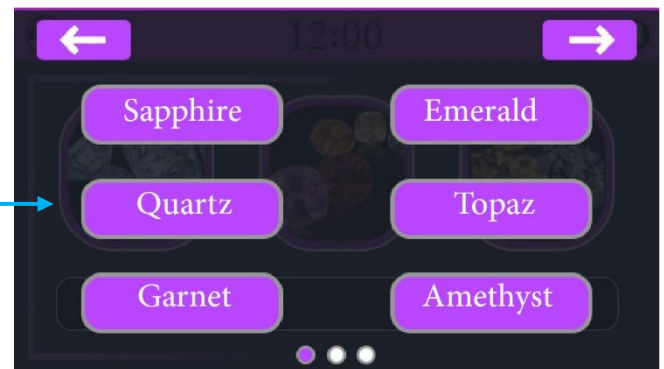

You can choose the target you want to search for.  
(Example: Quartz), which also appears in the front range



Then choose the front range you want to reach (from 100 meters to 500 meters - 1000 meters - 1500 meters - 2000 meters - 2500 meters - 3000 meters) (for example, 500 meters)

Example: If the front range of the target to be searched is expected to be within an area of 500 square meters, it is sufficient to specify the front range within 500 meters.

But if the front range of the target to be searched is unknown, you can specify the front range up to 3000 meters.

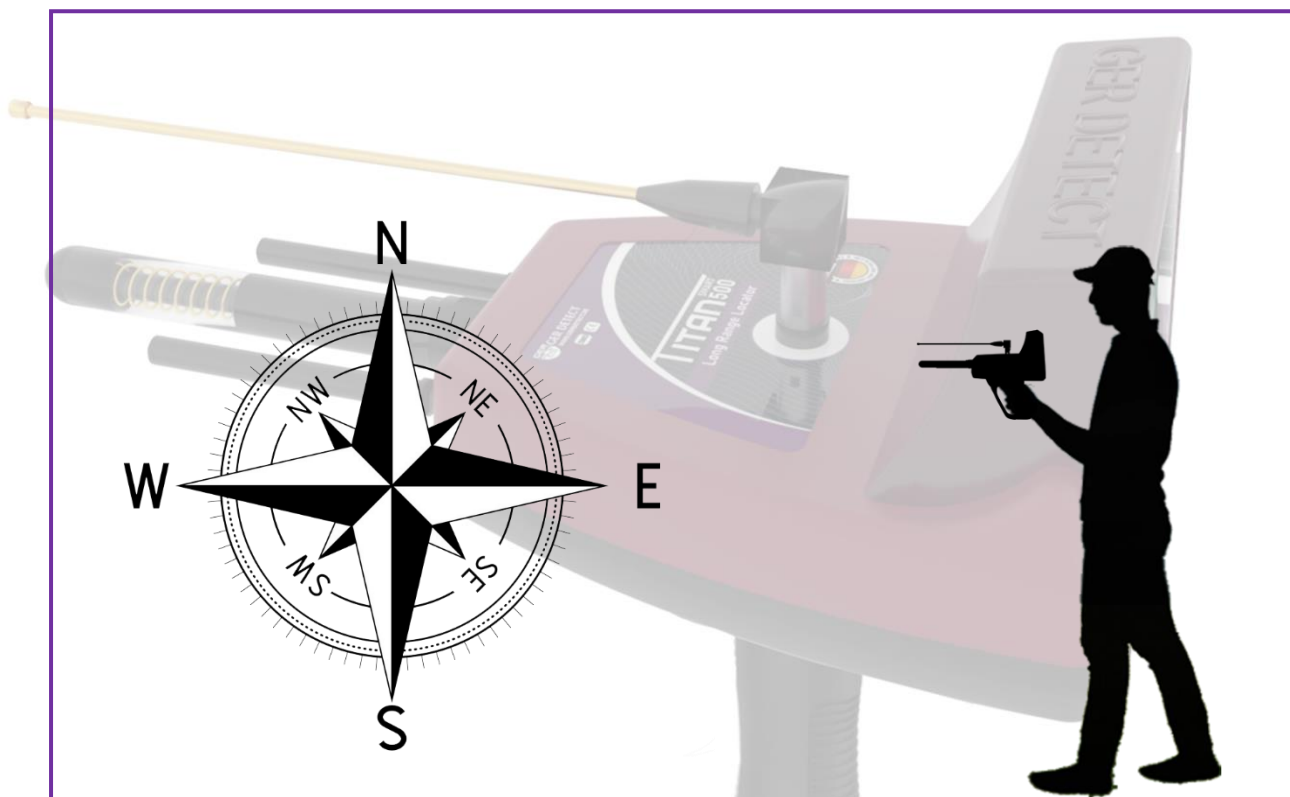

Note: The explorer must stand facing north to south.

Whereas, the ionic fields are radiation emitted by gold, minerals, buried treasures, diamond, gemstones and voids after being underground for a long time, and their overlap and interaction with the soil and the nature of the earth's formation and its regularity with magnetic lines to the north and south.

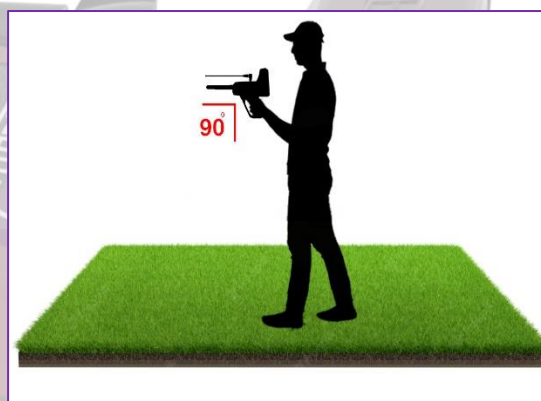
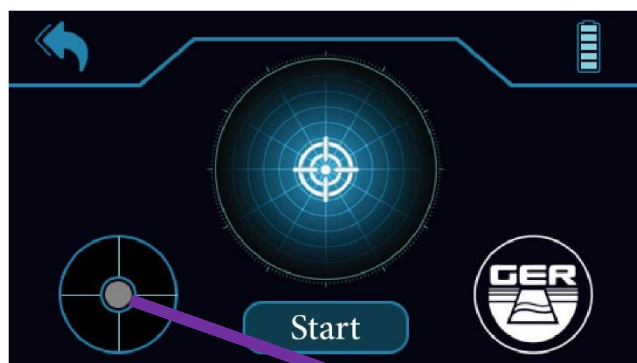

The balance of the device must be maintained during the search by fixing the yellow dot in the middle of the circle icon.

The device will start sending and receiving signals directing you towards the target with a continuous sound.

When getting any signal, the device will directly turn towards the target with the target direction indicator appearing on the screen and the sound accelerating.

Confirm the direction of the target from all four directions to ensure that the target is reached more precisely.

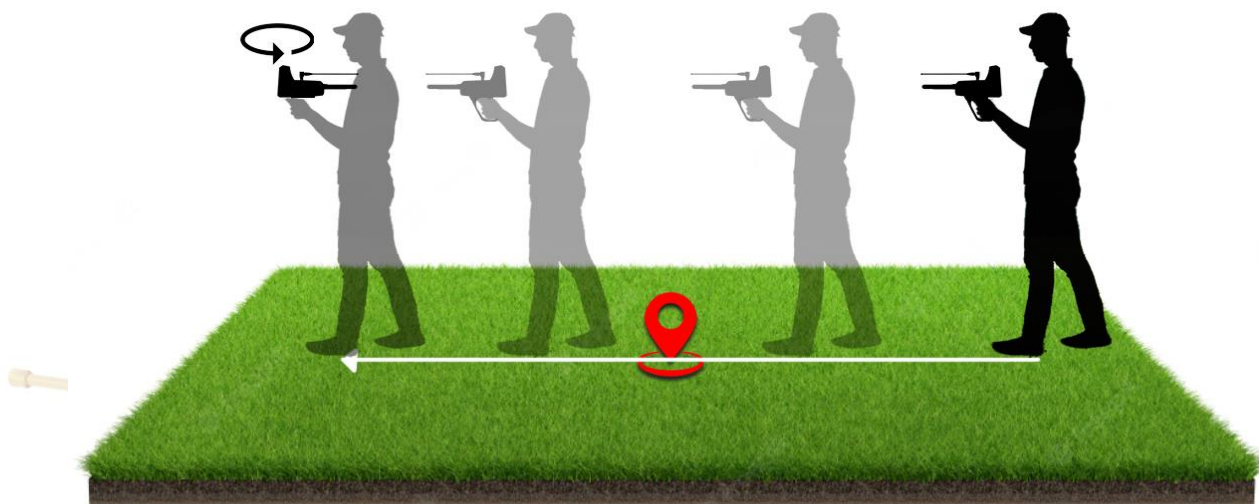

Follow the signal and when the device turns back you will have passed the target

Limit the search site by placing a mark that will be the center for target confirmation.

Then confirm the location of the target from the four directions (from south to north - from north to south - from west to east - from east to west).

When standing above the center of the target, the device will rotate directly above the target.

North to south

South to north

East to west

West to east

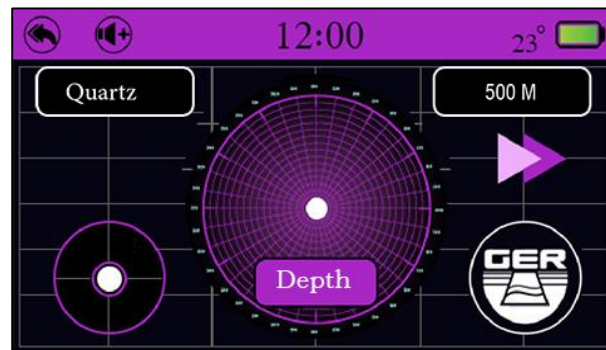
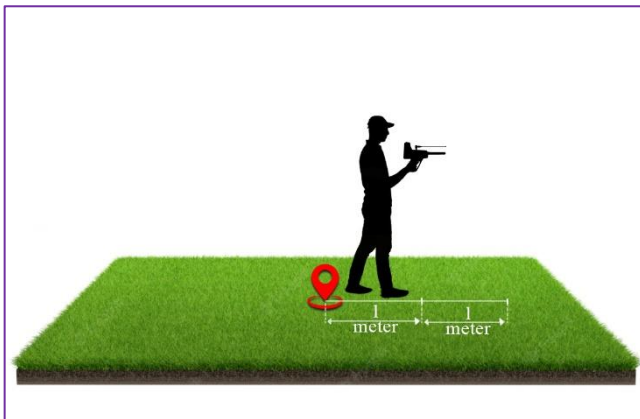

After you have confirmed the location of the target, click on the depth button to determine the depth and then move away from the center of the target a distance of at least two meters.

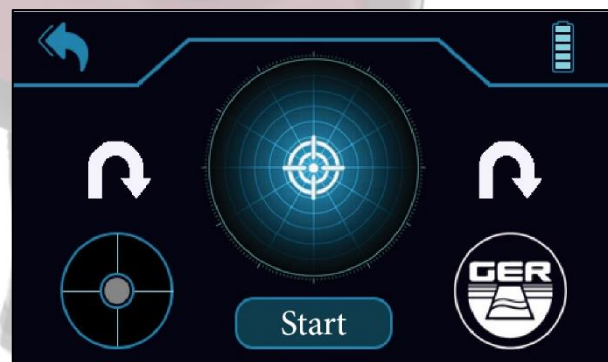
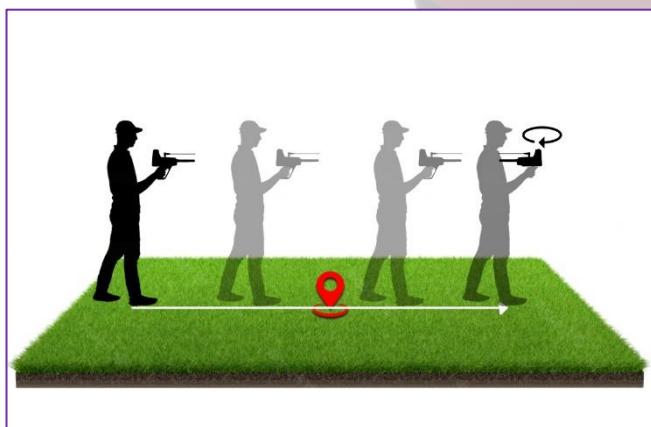

Point the device towards the target while maintaining the balance of the device, press the start button, wait until you hear a beep from the device, then walk towards the target until the device rotates backwards with the appearance of an icon indicating the rotation of the device towards the back.



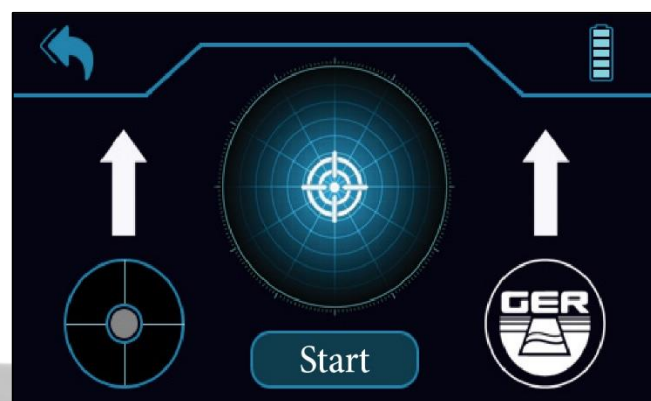
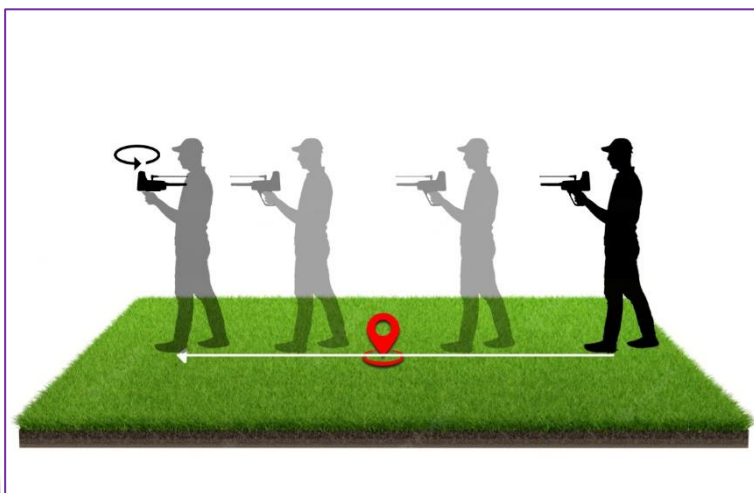

Turn in the opposite direction, press the start button, wait until you hear a beep emanating from the device, and the icon shifts from the rotation position to the forward position, then walk until the device rotates backwards, the device will analyze and show the final results automatically.



The following results and conditions will appear on the device screen when confirming the presence of a target:

**Noise Ratio:** It is the percentage of noise in the search area, which results from the proximity of (energy sources - phone networks - metals - mobile phones - electronic devices)

**Confirm Target:** the percentage of confirmation of the presence of the target in the search area.

**Depth:** The depth within which the target is likely to be located.

Example: the depth is between 0.91 cm to 1.24 cm.

-Noise 5%

-Target confirmation 92%

**Important Note:** The ratio to analyze the results in the Titan 500 Smart is as follows:

If the result of the noise is high and the target confirmation rate is low: The device does not give depth, it is rather to retry the search again.

If it gives us depth and the noise percentage is greater than 30% It is preferable to try the search again.









if the target confirmation rate is less than 90% it is recommended to try the search again.

**Note:** The target must be buried for many years so that by the time and the interaction with the soil's composition, an ionic field will be formed which will enable the device to detect the target.

Therefore, testing the device on metals laid on the ground or newly buried under the ground will not show the real capacity and functionality of this device to detect the target or to reach larger depths.

The reason for that is that the ionic fields are radiations from gold and other metals that have been in the ground for a long time and have intersected and interacted with the soil and the nature of the earth as well as having been regulated with magnetic fields north and south – These features do not apply for freshly buried or surface laid gold, diamond, gemstones and other metals.

## The device parts and accessories

	<p>A carrying and protective device case made of shock-resistant plastic</p>
	<p>The main unit of the device</p>
	<p>The device handle</p>
	<p>The device charger</p>
	<p>The car charger</p>
	<p>Super antenna</p>
	<p>Enhancer antennas</p>
	<p>Recipient antenna</p>

## The technical specifications

<b>Titan 500 Smart Technical Specifications</b>	
<b>Audio Output</b>	Dynamic speaker frequency range: 350~5500 Hz Sound output: 84 ± 3dB
<b>Liquid Crystal Display (LCD)</b>	touch screen full color 480 x 272 px
<b>Length</b>	Device: 218 mm
	Device with super antenna 388 mm
	The device with golden antenna of 462 mm
<b>Frequency</b>	3.2 _ 18 KHz
<b>Data processing speed</b>	180 MHz
<b>Operating Temperature Range</b>	0 C° to 70 C°
<b>Operating Humidity Range</b>	Up to 95 % non-condensing
<b>Storage Temperature Range</b>	- 20C° to 70C°
<b>Storage Humidity Range</b>	Up to 98 % Relative Humidity
<b>Operating Time (27 Wh Battery)</b>	10 Hours
<b>Waterproof Rating - Detector</b>	Not waterproof (weatherproof only)
<b>Li-ion Battery Technical Specifications</b>	
<b>Type</b>	Li-ion Rechargeable Battery - internal Battery
<b>Output Voltage</b>	Li-ion 3.6 VDC
<b>Capacity</b>	Li-ion 27 Wh
<b>Run Time</b>	10 Hours
<b>Battery Operating Temperature</b>	0 C° to 50 C°
<b>Battery Storage Temperature</b>	- 5C° to 70C°
<b>Li-ion Battery Charger Technical Specifications</b>	
<b>Operating Temperature</b>	0 C° to 50 C°
<b>Storage Temperature</b>	- 30 C° to 80 C°
<b>Input Voltage</b>	90 → 250 VAC 50→60 Hz
<b>USB Output Current</b>	5 VDC / 2100 mA
<b>Other Technical Specifications</b>	
<b>Total weight</b>	4865 g
<b>Device weight</b>	592 g
<b>Battery weight</b>	130 g
<b>Bag weight (empty)</b>	3730 g
<b>Bag dimensions</b>	530 mm x 400 mm x 228 mm